

THE PROPERTY OF THE DRAWING IS ESTABLISHED BY LAW. IT IS FORBIDDEN TO PRODUCE OR SHOW IT TO THIRD PARTY, WITHOUT A WRITTEN AGREEMENT.

Item	Name	Q. ty
1	CA.GWP.5.40	2
2	R.5.SCH	8
3	SVB.X.50.25	1
4	V.TCE5x12	8

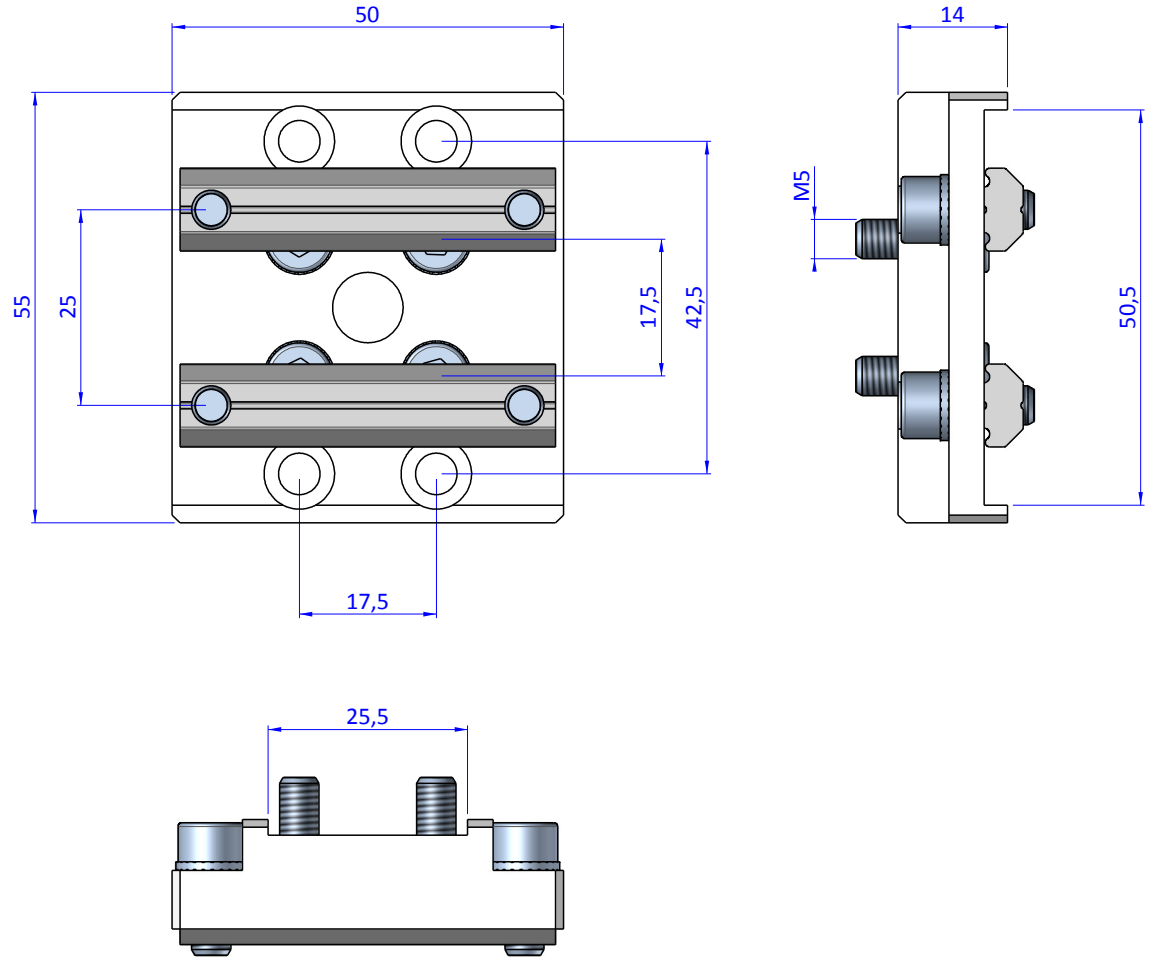
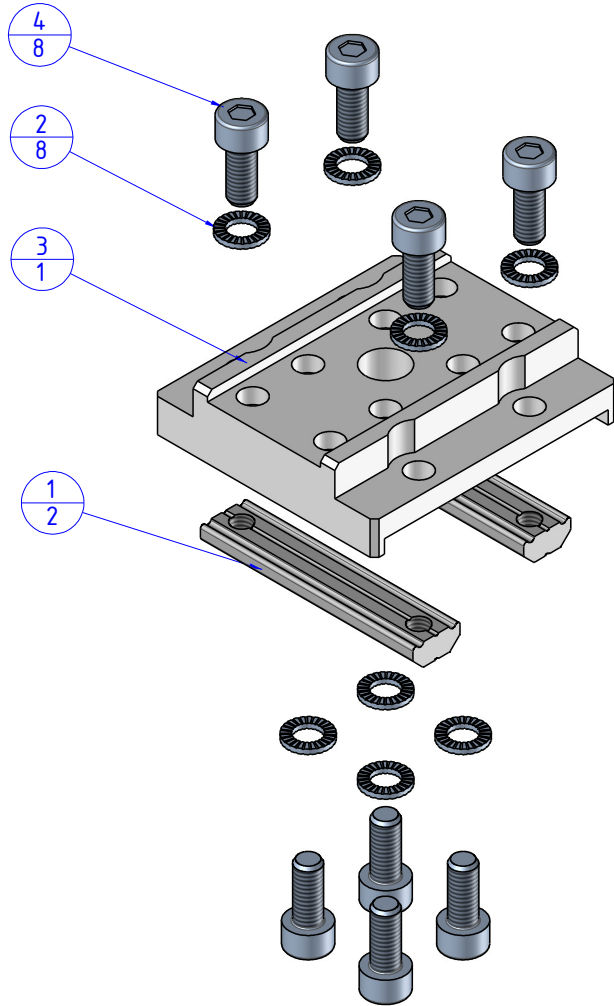

Format A3

UNI 936-76

		DESIGNED FROM		REVIEW
		FPSERVICES		A
GENERAL TOLERANCE		DATE	WEIGHT	
UNI - ISO 2768		30/04/2016	0,114kg	
CLASSE f		CODE		
		CA.SVB.X.50.25		CA.SVB.X.50.25